

# Uninetco

## GigaRate Series Fiber Optic Adapter 100G Support

Product Catalogue

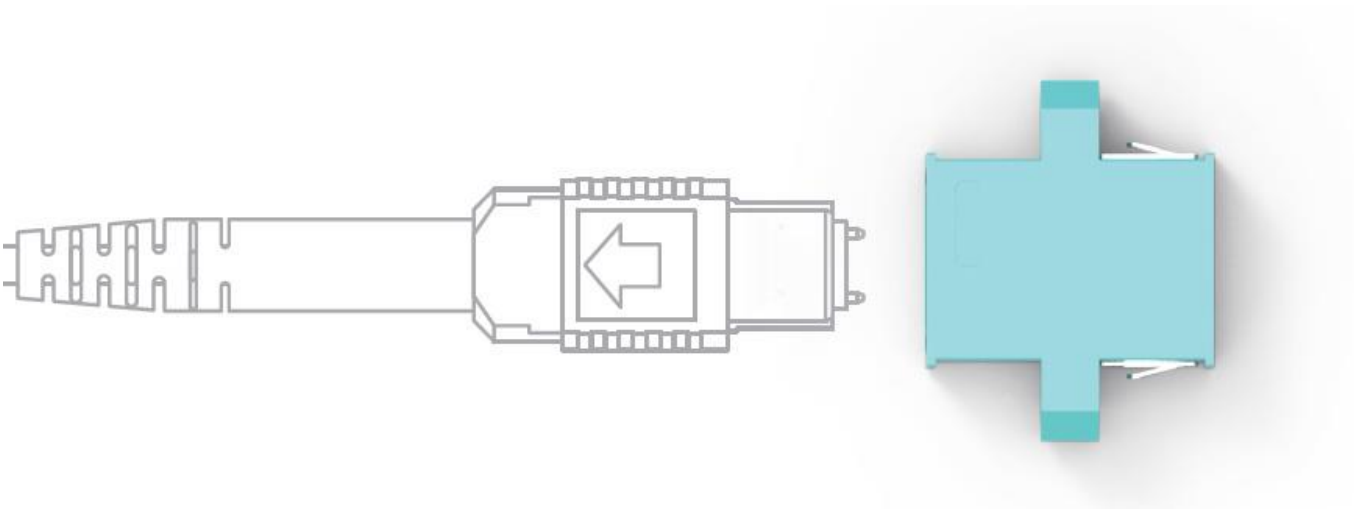

# Contents



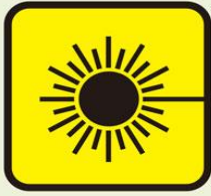

---

Anti-Laser DLC Adapter	1
Up-down Clip DLC Adapter	4
Inner Shutter DLC Adapter	7
GigaRate Series LC Adapter	10
GigaRate Series SC Adapter	15
MPO Adapter	20
Other Adapter	23

---



GigaRate Series  
Anti-Laser  
Fiber Optic Adapters

-  No.: NGBEC1903201703
-  No.: 20180922-E500985
-  No.: ATL20181026850
-  No.: ZL 2017 2 1097720.X

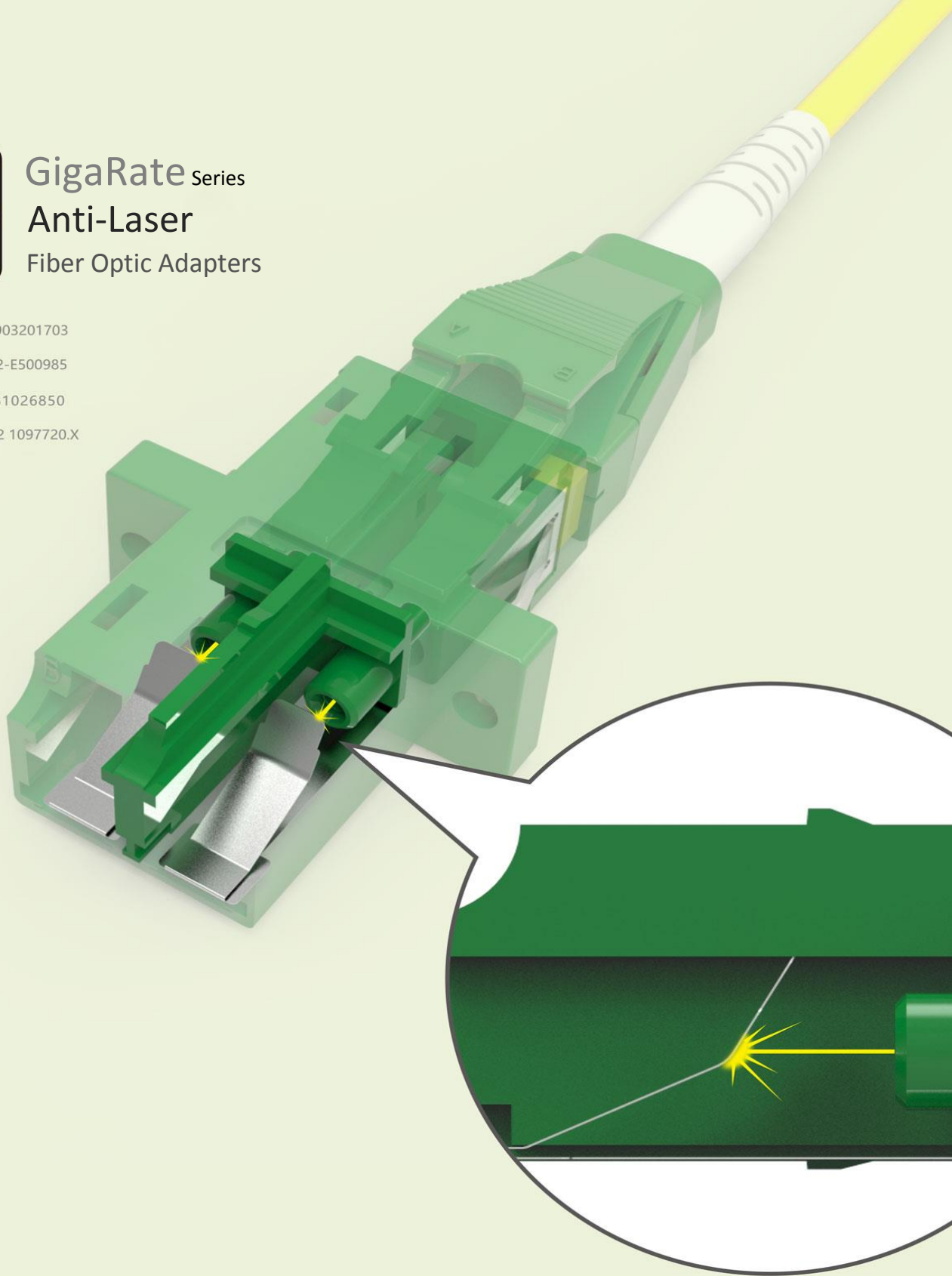

## Anti-Laser LC Duplex without Flange

### Fiber Optic Adapters

- Design of Internal Metal shutter
- Tripe Sides Tight Fix Clip
- Unibody shell
- With Grade A Ceramic Sleeve 100G Support





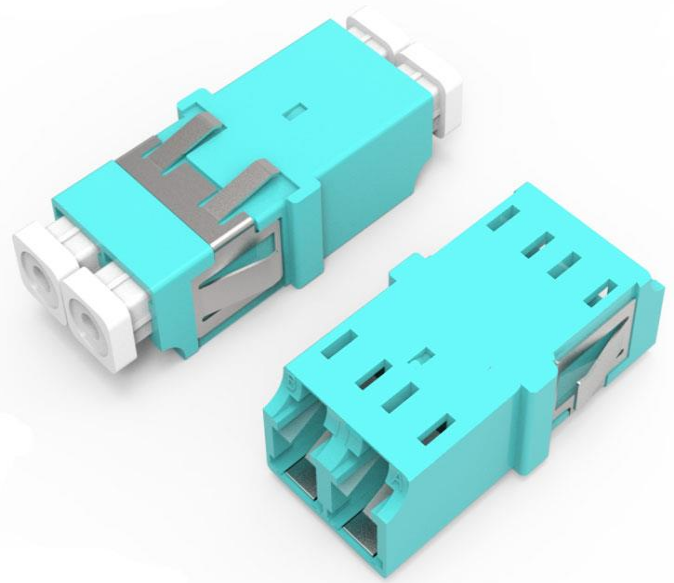

**Technical Parameter:** IL≤0.2db(SM) / IL≤0.1db (MM)

**Material:** High-Quality PC (UL94-V0)

**Mechanical Durability:** ≥1000/Boot

**Applications:** Fiber Optic Cassettes / Fiber Optic Patch Panel/  
Fiber Optic Distribution Box/ Fiber Optic Technical Box and  
others to realize the connectivity



Mode	Part Number	Color Code	Photo
SM/UPC	G2S10-10W BLU AL	Pantone 2151 C	
SM/APC	G2S5-5W GRE AL	Pantone 7739 C	
OM1/OM2	G2M10-10W BEI AL	Pantone 481 C	
OM3	G2OM10-10W AQU AL	Pantone 564 C	
OM4	G2LM10-10W MAG AL	Pantone 7432 C	
OM5	G2XM10-10W LIME AL	Pantone 2300 C	

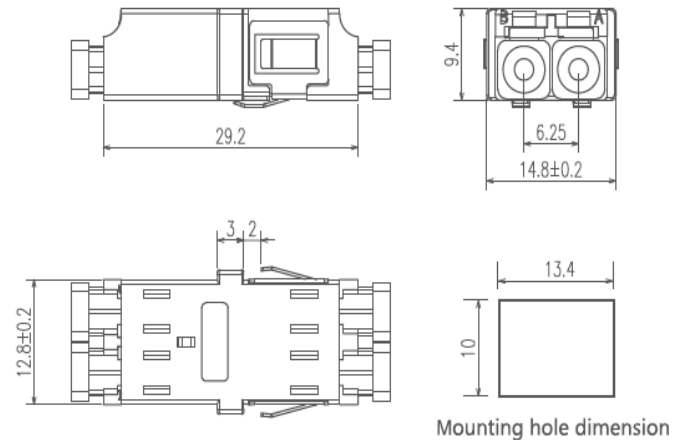

## Anti-Laser Duplex LC with Flange

### Fiber Optic Adapters

- Design of Internal Metal shutter
- Tripe Sides Tight Fix Clip
- Unibody shell
- With Grade A Ceramic Sleeve 100G Support

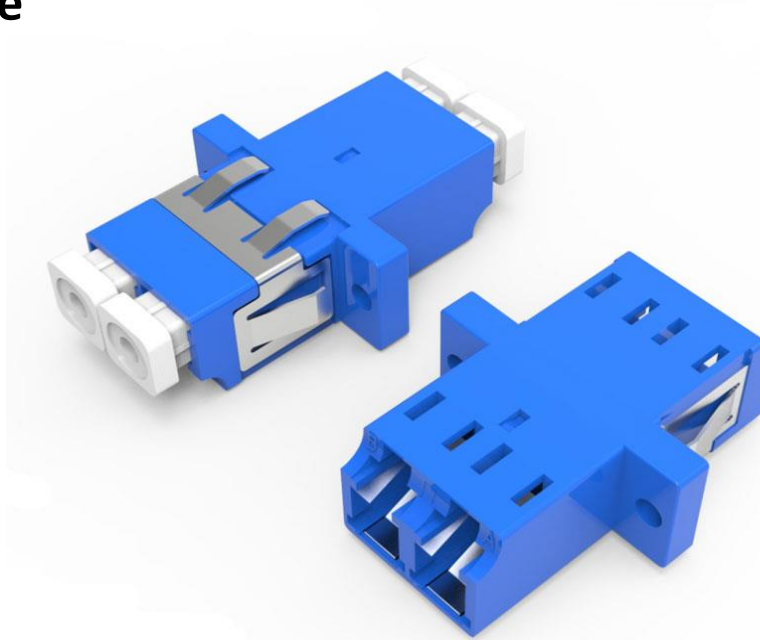







**Technical Parameter:** IL≤0.2db(SM) / IL≤0.1db (MM)

**Material:** High-Quality PC (UL94-V0)

**Mechanical Durability:** ≥1000/Boot

**Applications:** Fiber Optic Cassettes / Fiber Optic Patch Panel/  
Fiber Optic Distribution Box/ Fiber Optic Technical Box and  
others to realize the connectivity

Mode	Part Number	Color Code	Photo
SM/UPC	G2S10-10F BLU AL	Pantone 2151 C	
SM/APC	G2S5-5F GRE AL	Pantone 7739 C	
OM1/OM2	G2M10-10F BEI AL	Pantone 481 C	
OM3	G2OM10-10F AQU AL	Pantone 564 C	
OM4	G2LM10-10F MAG AL	Pantone 7432 C	
OM5	G2XM10-10F LIME AL	Pantone 2300 C	

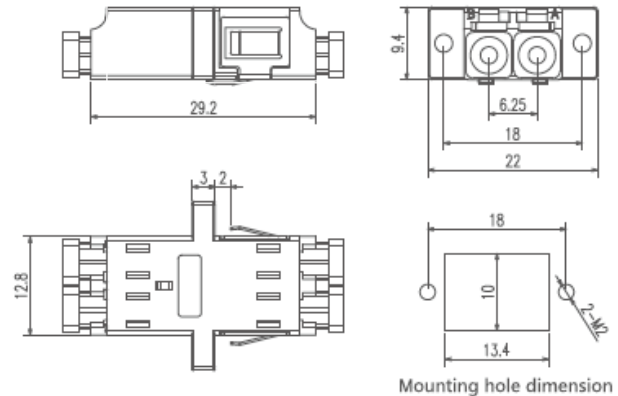



# Up-down Clip Duplex LC Fiber Optic Adapters



NO.:NGBEC1903201703



NO.:20180922-ES00985



NO.:ATL20181026850

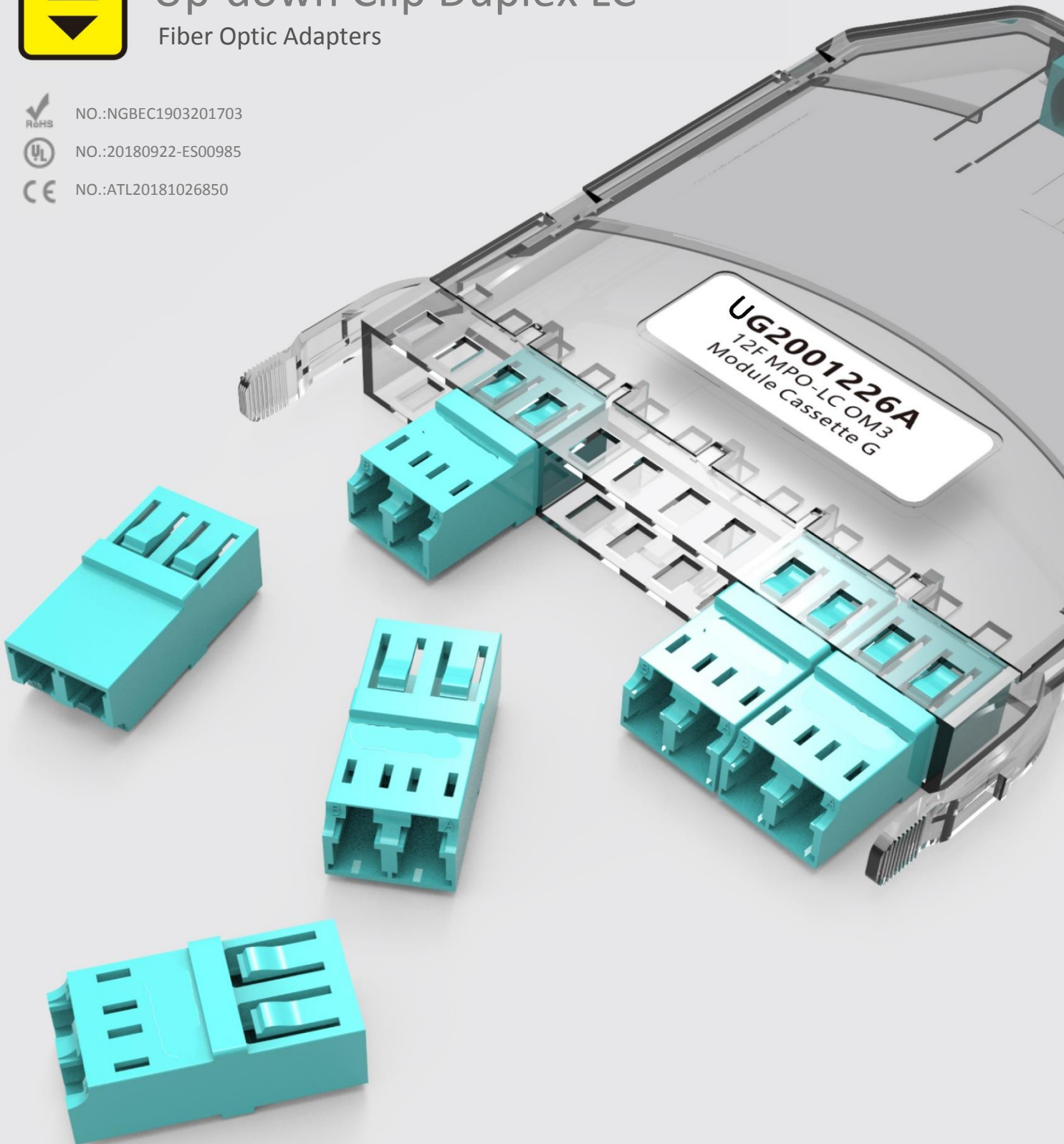

GigaRate Series Adapters 100G Support

## Up-down Clip Duplex LC

Fiber Optic Adapters

- Up-down Clip
- Design for SP Series MPO Cassette
- Unibody shell
- With Grade A Ceramic Sleeve 100G Support

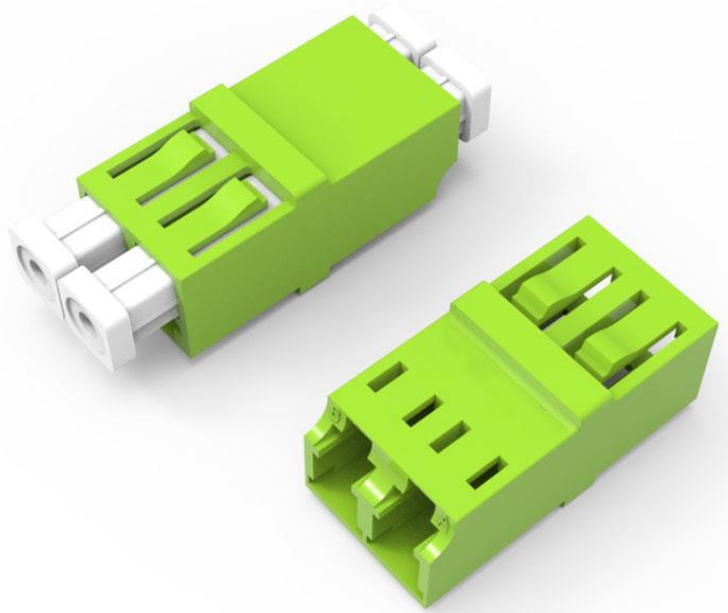

**Technical Parameter:** IL≤0.2db(SM) / IL≤0.1db (MM)

**Material:** High-Quality PC (UL94-V0)

**Mechanical Durability:** ≥1000/Boot

**Applications:** Special Use of Series MPO Cassette

Mode	Part Number	Color Code	Photo
SM/UPC	G2S10-10 BLU UP	Pantone 2151 C	
SM/APC	G2S5-5 GRE UP	Pantone 7739 C	
OM1/OM2	G2M10-10 BEI UP	Pantone 481 C	
OM3	G2OM10-10 AQU UP	Pantone 564 C	
OM4	G2LM10-10 MAG UP	Pantone 7432 C	
OM5	G2XM10-10 LIME UP	Pantone 2300 C	

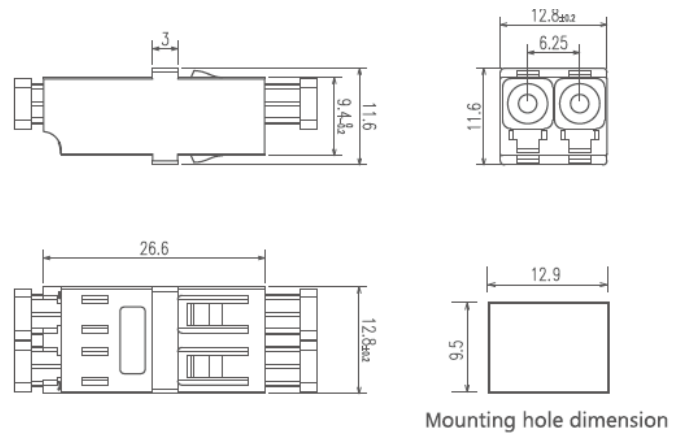

GigaRate Series Adapters 100G Support

# Up-down Clip Inner Shutter Duplex LC

Fiber Optic Adapters

- Up-down Clip
- Inner Shutter
- Unibody shell
- With Grade A Ceramic Sleeve 100G Support





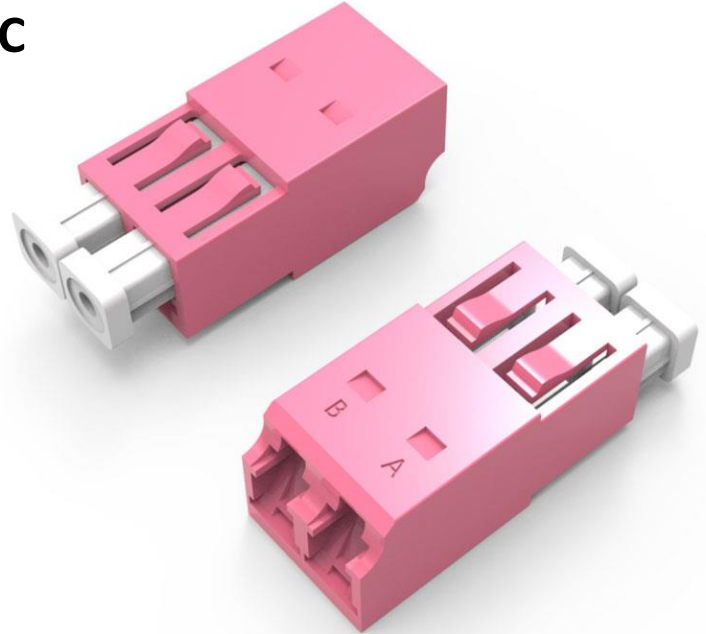

**Technical Parameter:** IL≤0.2db(SM) / IL≤0.1db (MM)

**Material:** High-Quality PC (UL94-V0)

**Mechanical Durability:** ≥1000/Boot

**Applications:** Special Use of Series MPO Cassette



Mode	Part Number	Color Code	Photo
SM/UPC	G2S10-10 BLU SHUP	Pantone 2151 C	
SM/APC	G2S5-5 GRE SHUP	Pantone 7739 C	
OM1/OM2	G2M10-10 BEI SHUP	Pantone 481 C	
OM3	G2OM10-10 AQU SHUP	Pantone 564 C	
OM4	G2LM10-10 MAG SHUP	Pantone 7432 C	
OM5	G2XM10-10 LIME SHUP	Pantone 2300 C	

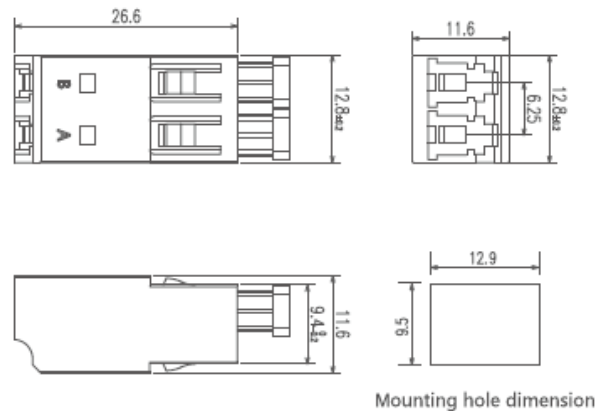





GigaRate Series  
**Elite Inner Shutter DLC**  
Fiber Optic Adapters



NO.: NGBEC1903201703



NO.: 20180922-E500985



NO.: ATL20181026850



NO.: ZL 2017 2 1097720.X

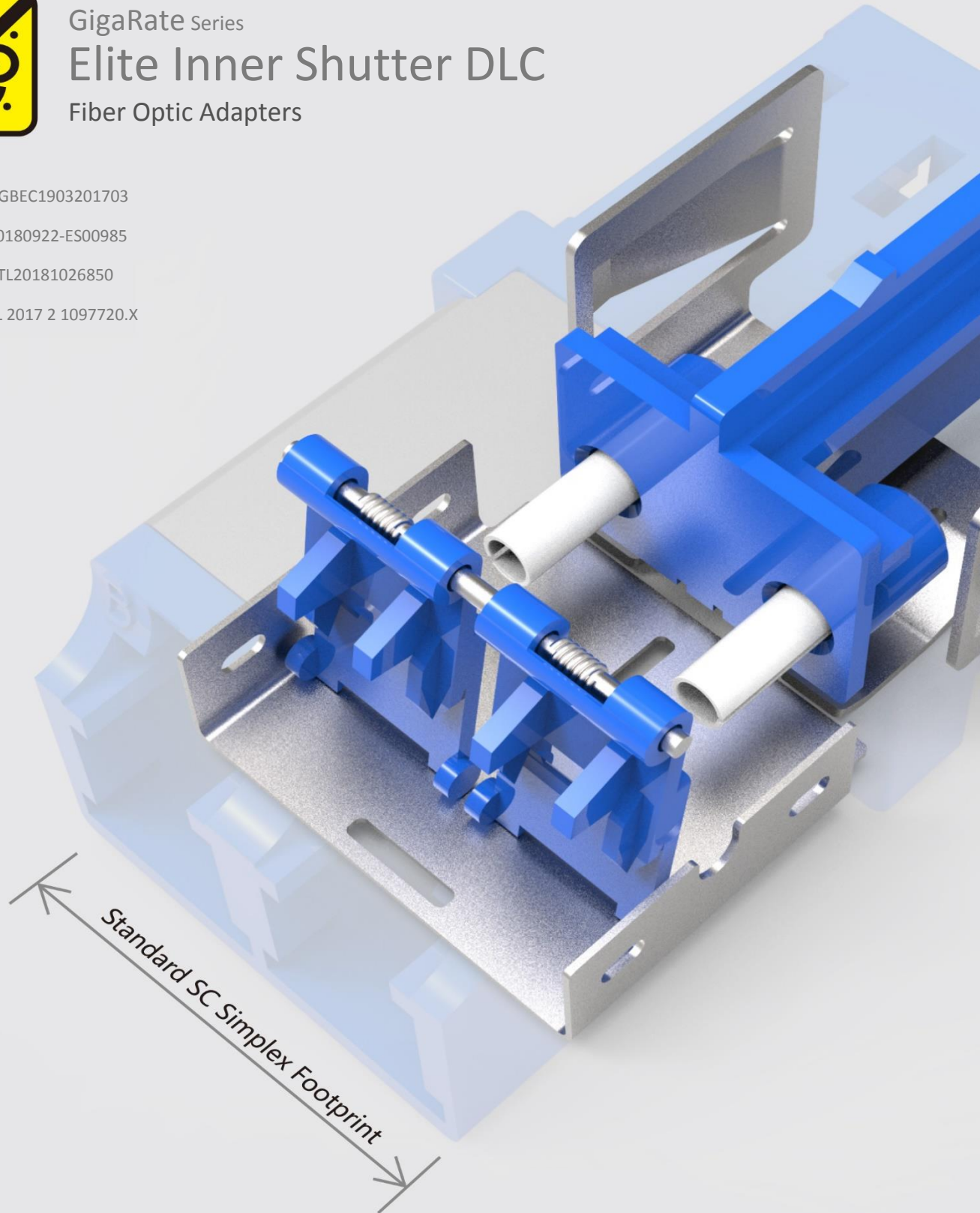

Standard SC Simplex Footprint



GigaRate Series  
**Elite Inner Shutter DLC**  
Fiber Optic Adapters



NO.: NGBEC1903201703



NO.: 20180922-ES00985



NO.: ATL20181026850



NO.: ZL 2017 2 1097720.X

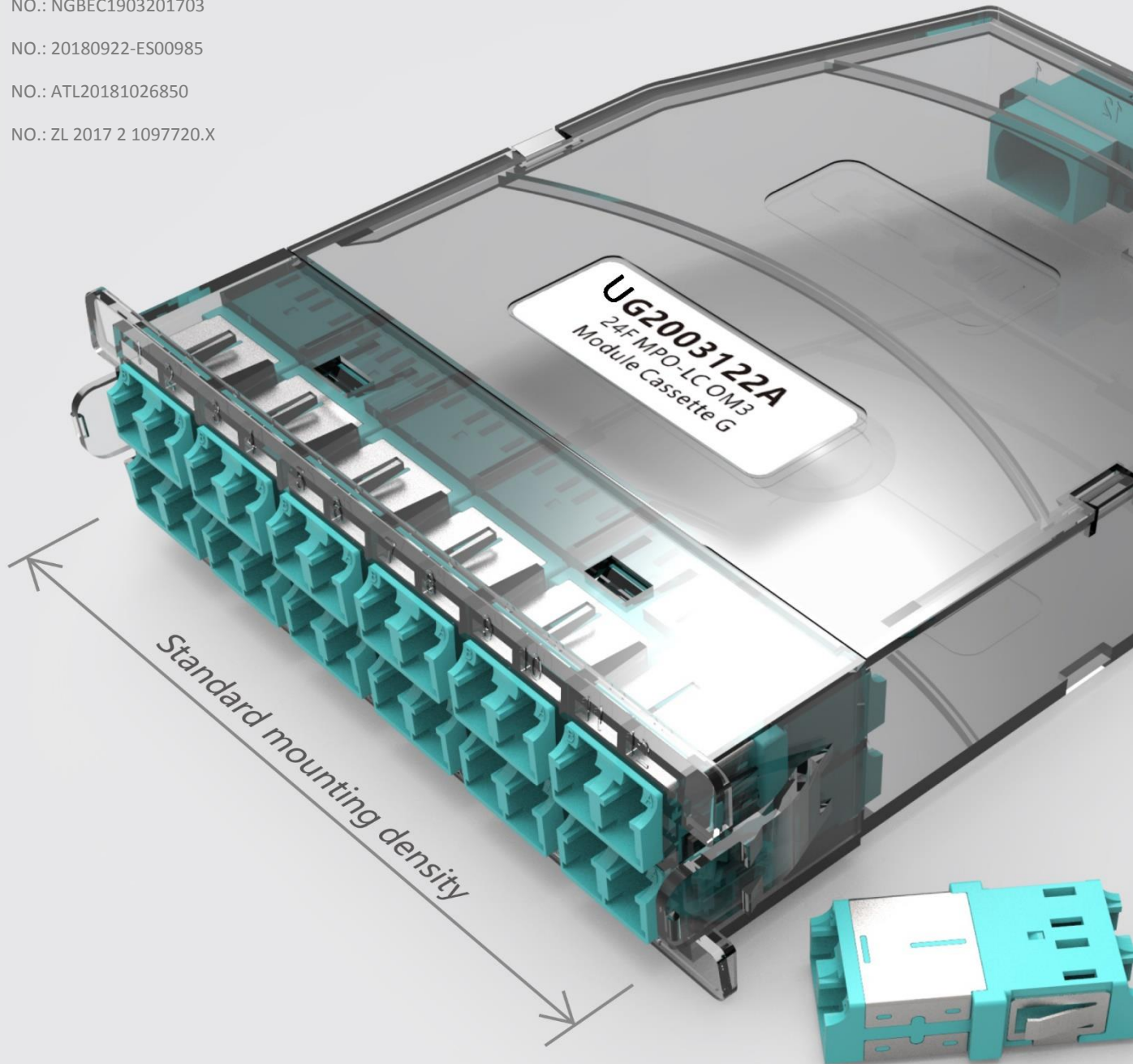

**Uninetco**

GigaRate Connected

GigaRate Series Adapters 100G Support

## Elite Inner Shutter DLC

Fiber Optic Adapters

- Elite Inner Shutter DLC
- Standard SC Simplex Footprint Standard mounting density
- Triple Sides Tight Fix Clip
- With Grade A Ceramic Sleeve 100G Support

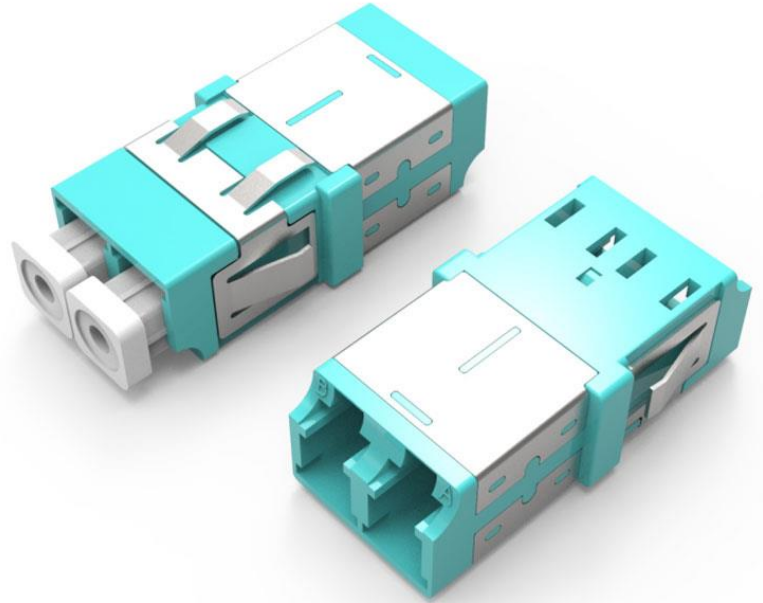







**Technical Parameter:**  $IL \leq 0.2\text{db(SM)}$  /  $IL \leq 0.1\text{db (MM)}$

**Material:** High-Quality PC (UL94-V0)

**Mechanical Durability:**  $\geq 1000/\text{Boot}$

**Applications:** Fiber Optic Cassettes / Fiber Optic Patch Panel/  
Fiber Optic Distribution Box/ Fiber Optic Technical Box and  
others to realize the connectivity

Mode	Part Number	Color Code	Photo
SM/UPC	G2S10-10 BLU SH	Pantone 2151 C	
SM/APC	G2S5-5 GRE SH	Pantone 7739 C	
OM1/OM2	G2M10-10 BEI SH	Pantone 481 C	
OM3	G2OM10-10 AQU SH	Pantone 564 C	
OM4	G2LM10-10 MAG SH	Pantone 7432 C	
OM5	G2XM10-10 LIME SH	Pantone 2300 C	

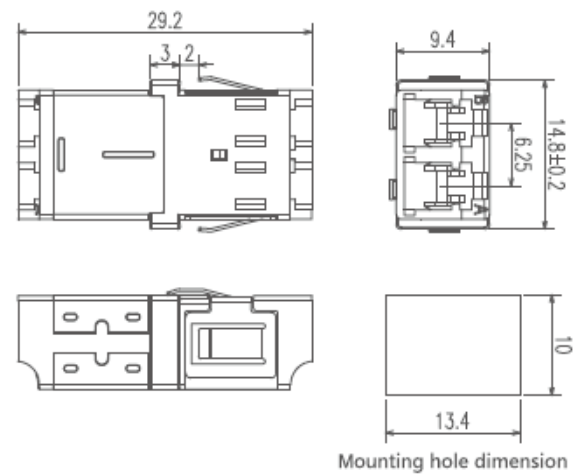

# LC

## GigaRate Series Fiber Optic Adapters



NO.: NGBEC1903201703



NO.: 20180922-ES00985



NO.: ATL20181026850



NO.: ZL 2017 2 1097720.X

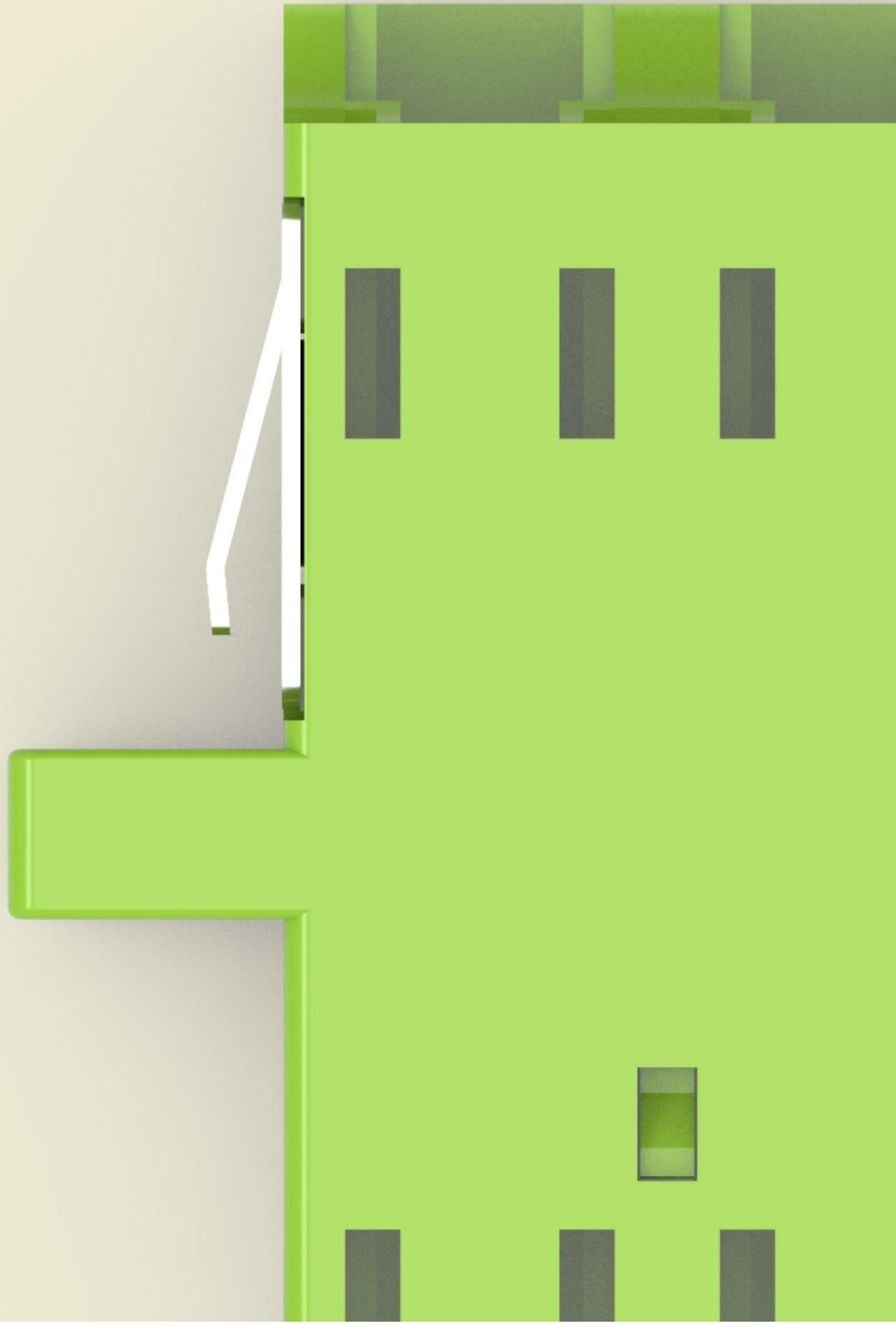

**Uninetco**

GigaRate Connected

GigaRate Series Adapters 100G Support

## Duplex LC without Flange

Fiber Optic Adapters

- Tripe Sides Tight Fix Clip
- Unibody shell
- With Grade A Ceramic Sleeve 100G Support

**Technical Parameter:** IL≤0.2db(SM) / IL≤0.1db (MM)

**Material:** High-Quality PC (UL94-V0)

**Mechanical Durability:** ≥1000/Boot

**Applications:** Fiber Optic Cassettes / Fiber Optic Patch Panel/  
Fiber Optic Distribution Box/ Fiber Optic Technical Box and  
others to realize the connectivity

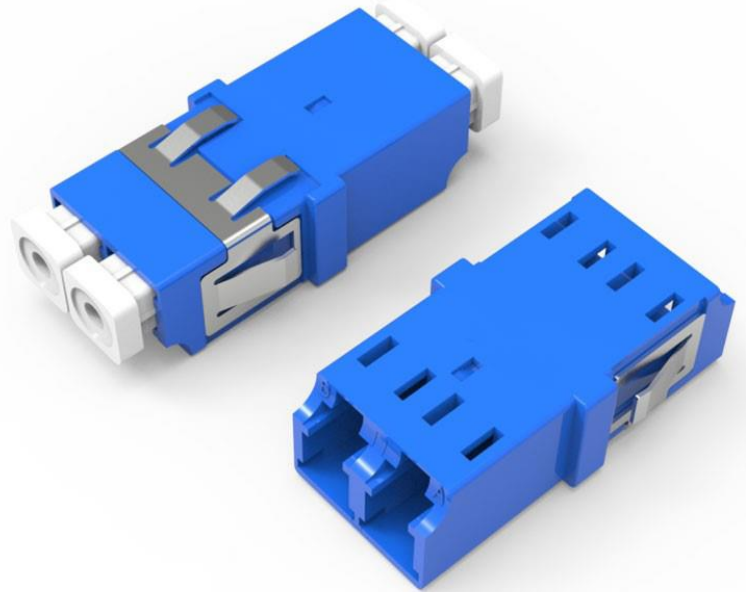

Mode	Part Number	Color Code	Photo
SM/UPC	G2S10-10W BLU	Pantone 2151 C	
SM/APC	G2S5-5W GRE	Pantone 7739 C	
OM1/OM2	G2M10-10W BEI	Pantone 481 C	
OM3	G2OM10-10W AQU	Pantone 564 C	
OM4	G2LM10-10W MAG	Pantone 7432 C	
OM5	G2XM10-10W LIME	Pantone 2300 C	

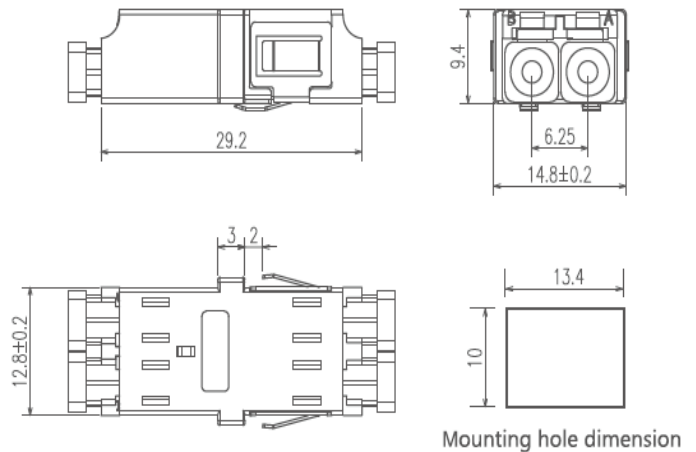

GigaRate Series Adapters 100G Support

## Duplex LC with Flange

Fiber Optic Adapters

- Tripe Sides Tight Fix Clip
- Unibody shell
- With Grade A Ceramic Sleeve 100G Support



**Technical Parameter:** IL≤0.2db(SM) / IL≤0.1db (MM)

**Material:** High-Quality PC (UL94-V0)

**Mechanical Durability:** ≥1000/Boot

**Applications:** Fiber Optic Cassettes / Fiber Optic Patch Panel/  
Fiber Optic Distribution Box/ Fiber Optic Technical Box and  
others to realize the connectivity

Mode	Part Number	Color Code	Photo
SM/UPC	G2S10-10F BLU	Pantone 2151 C	
SM/APC	G2S5-5F GRE	Pantone 7739 C	
OM1/OM2	G2M10-10F BEI	Pantone 481 C	
OM3	G2OM10-10F AQU	Pantone 564 C	
OM4	G2LM10-10F MAG	Pantone 7432 C	
OM5	G2XM10-10F LIME	Pantone 2300 C	

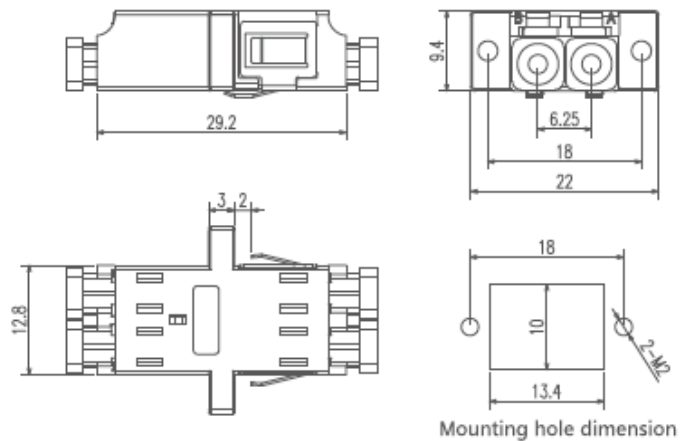

GigaRate Series Adapters 100G Support

## Quad LC without Flange

Fiber Optic Adapters

- Tripe Sides Tight Fix Clip
- Unibody shell
- With Grade A Ceramic Sleeve 100G Support

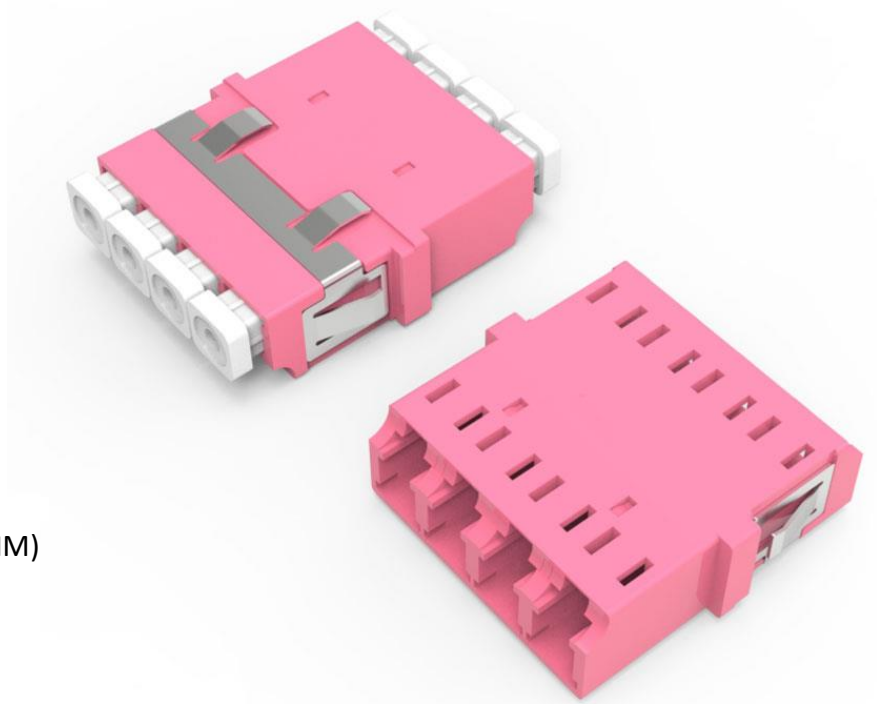

**Technical Parameter:** IL≤0.2db(SM) / IL≤0.1db (MM)

**Material:** High-Quality PC (UL94-V0)

**Mechanical Durability:** ≥1000/Boot

**Applications:** Fiber Optic Cassettes / Fiber Optic Patch Panel/  
Fiber Optic Distribution Box/ Fiber Optic Technical Box and others to realize the connectivity

Mode	Part Number	Color Code	Photo
SM/UPC	G4S10-10W BLU	Pantone 2151 C	
SM/APC	G4S5-5W GRE	Pantone 7739 C	
OM1/OM2	G4M10-10W BEI	Pantone 481 C	
OM3	G4OM10-10W AQU	Pantone 564 C	
OM4	G4LM10-10W MAG	Pantone 7432 C	
OM5	G4XM10-10W LIME	Pantone 2300 C	

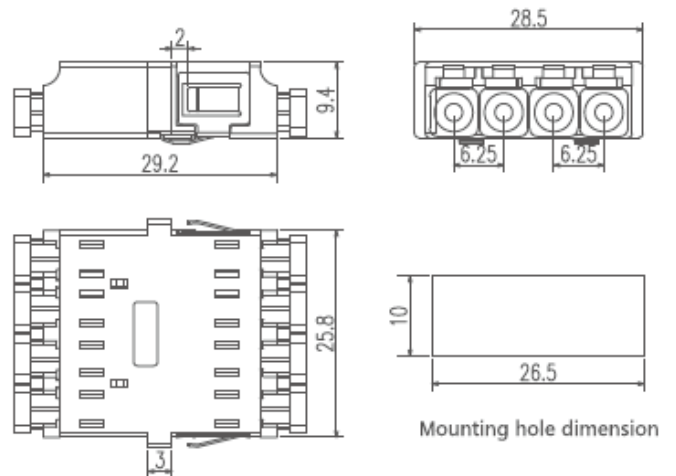

GigaRate Series Adapters 100G Support

## Quad LC with Flange

Fiber Optic Adapters

- Tripe Sides Tight Fix Clip
- Unibody shell
- With Grade A Ceramic Sleeve 100G Support





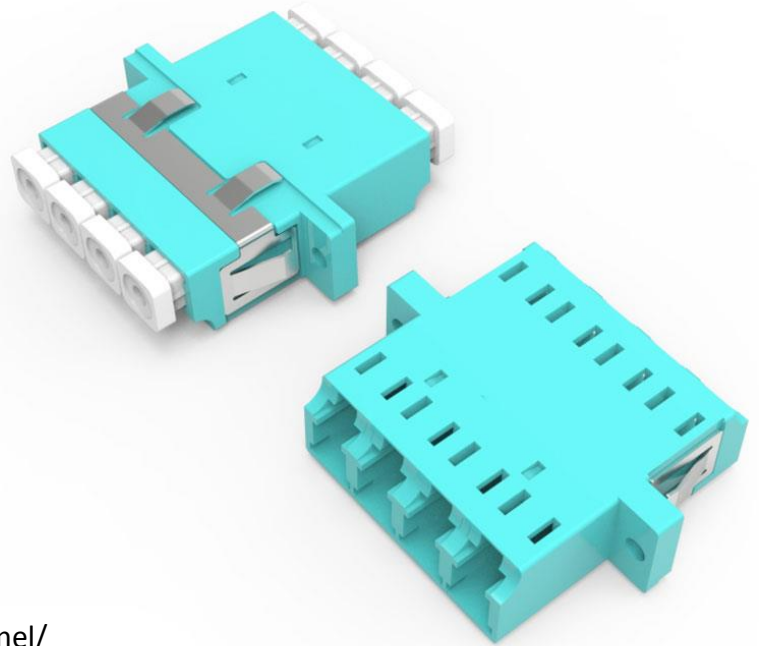

**Technical Parameter:** IL≤0.2db(SM) / IL≤0.1db (MM)

**Material:** High-Quality PC (UL94-V0)

**Mechanical Durability:** ≥1000/Boot

**Applications:** Fiber Optic Cassettes / Fiber Optic Patch Panel/  
Fiber Optic Distribution Box/ Fiber Optic Technical Box and  
others to realize the connectivity



Mode	Part Number	Color Code	Photo
SM/UPC	G4S10-10F BLU	Pantone 2151 C	
SM/APC	G4S5-5F GRE	Pantone 7739 C	
OM1/OM2	G4M10-10F BEI	Pantone 481 C	
OM3	G4OM10-10F AQU	Pantone 564 C	
OM4	G4LM10-10F MAG	Pantone 7432 C	
OM5	G4XM10-10F LIME	Pantone 2300 C	

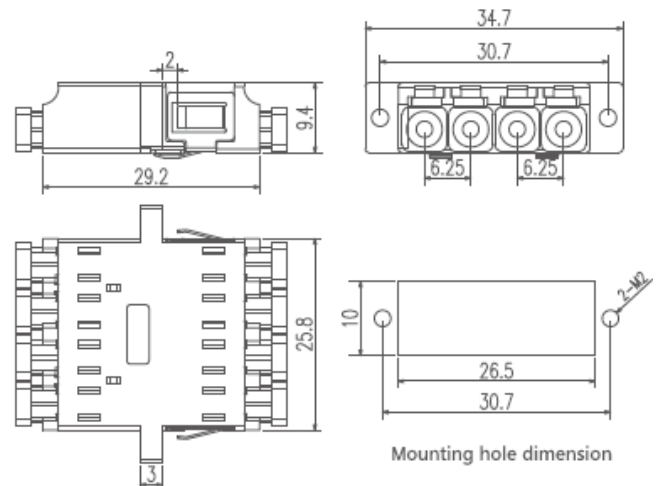



# SC

## GigaRate Series Fiber Optic Adapters



NO.: NGBEC1903201703



NO.: 20180922-ES00985



NO.: ATL20181026850



NO.: ZL 2017 2 1097720.X

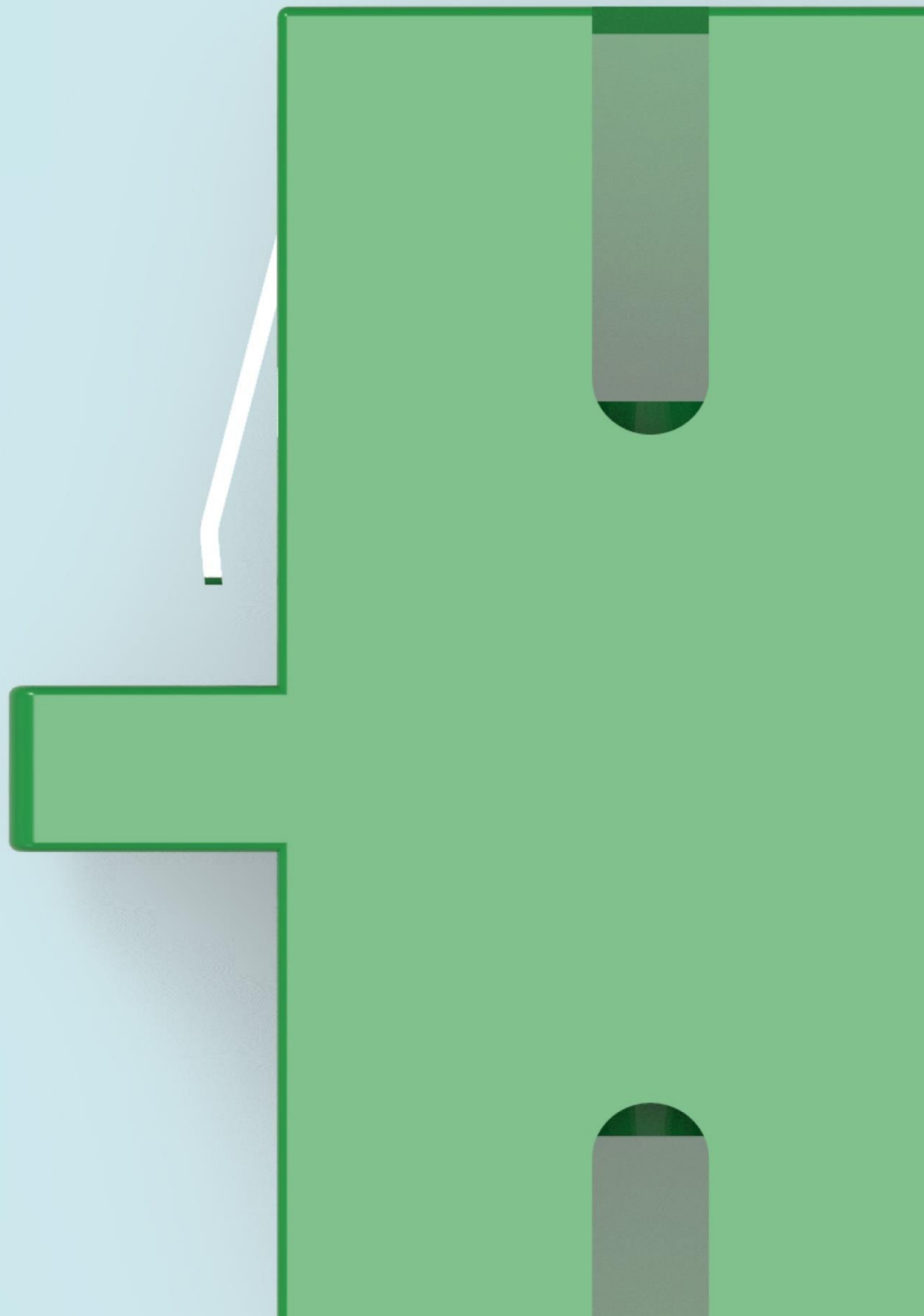

**Uninetco**

GigaRate Connected

GigaRate Series Adapters 100G Support

## SC Simplex without Flange

Fiber Optic Adapters

- Tripe Sides Tight Fix Clip
- Unibody shell
- With Grade A Ceramic Sleeve 100G Support





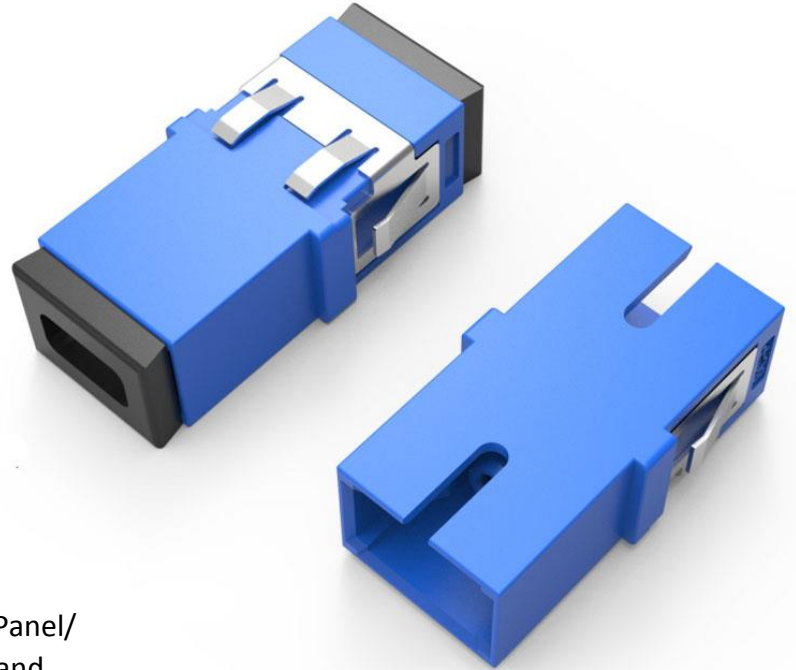

**Technical Parameter:** IL≤0.2db(SM) / IL≤0.1db (MM)

**Material:** PBT+GF (UL94-V0)

**Mechanical Durability:** ≥1000/Boot

**Applications:** Fiber Optic Cassettes / Fiber Optic Patch Panel/  
Fiber Optic Distribution Box/ Fiber Optic Technical Box and  
others to realize the connectivity



Mode	Part Number	Color Code	Photo
SM/UPC	G1S3-3W BLU	Pantone 2151 C	
SM/APC	G1S8-8W GRE	Pantone 7739 C	
OM1/OM2	G1M3-3W BEI	Pantone 481 C	
OM3	G1OM3-3W AQU	Pantone 564 C	
OM4	G1LM3-3W MAG	Pantone 7432 C	
OM5	G1XM3-3W LIME	Pantone 2300 C	

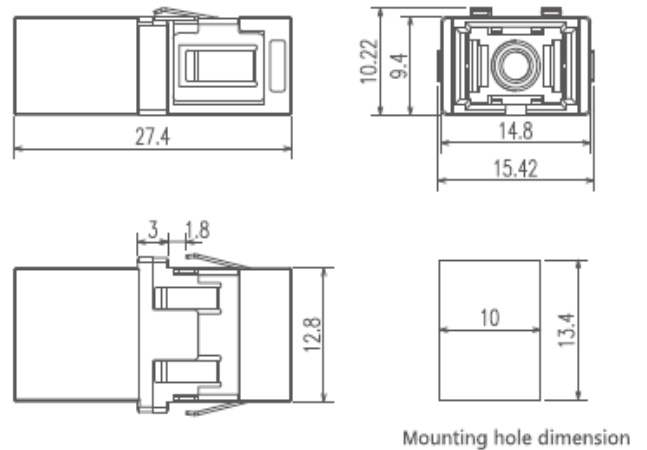

GigaRate Series Adapters 100G Support

## SC Simplex with Flange

Fiber Optic Adapters

- Tripe Sides Tight Fix Clip
- Unibody shell
- With Grade A Ceramic Sleeve 100G Support

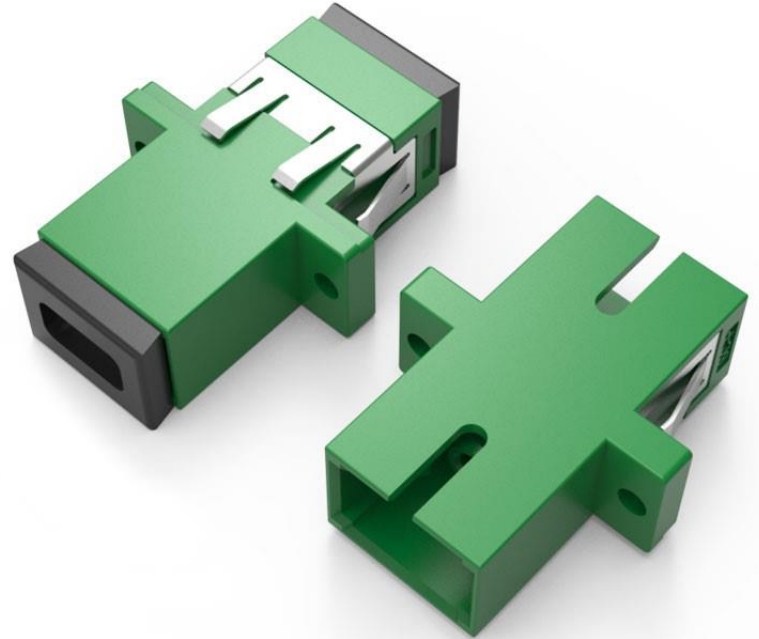







**Technical Parameter:**  $IL \leq 0.2\text{db(SM)}$  /  $IL \leq 0.1\text{db (MM)}$

**Material:** PBT+GF (UL94-V0)

**Mechanical Durability:**  $\geq 1000/\text{Boot}$

**Applications:** Fiber Optic Cassettes / Fiber Optic Patch Panel/  
Fiber Optic Distribution Box/ Fiber Optic Technical Box and  
others to realize the connectivity

Mode	Part Number	Color Code	Photo
SM/UPC	G1S3-3F BLU	Pantone 2151 C	
SM/APC	G1S8-8F GRE	Pantone 7739 C	
OM1/OM2	G1M3-3F BEI	Pantone 481 C	
OM3	G10M3-3F AQU	Pantone 564 C	
OM4	G1LM3-3F MAG	Pantone 7432 C	
OM5	G1XM3-3F LIME	Pantone 2300 C	

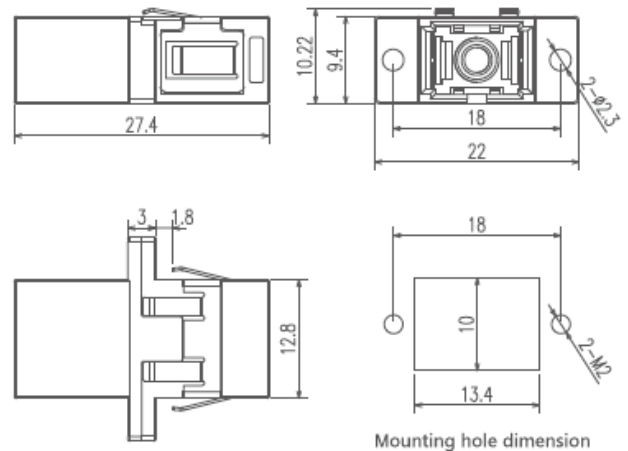

GigaRate Series Adapters 100G Support

## SC Duplex without Flange

Fiber Optic Adapters

- Tripe Sides Tight Fix Clip
- Unibody shell
- With Grade A Ceramic Sleeve 100G Support





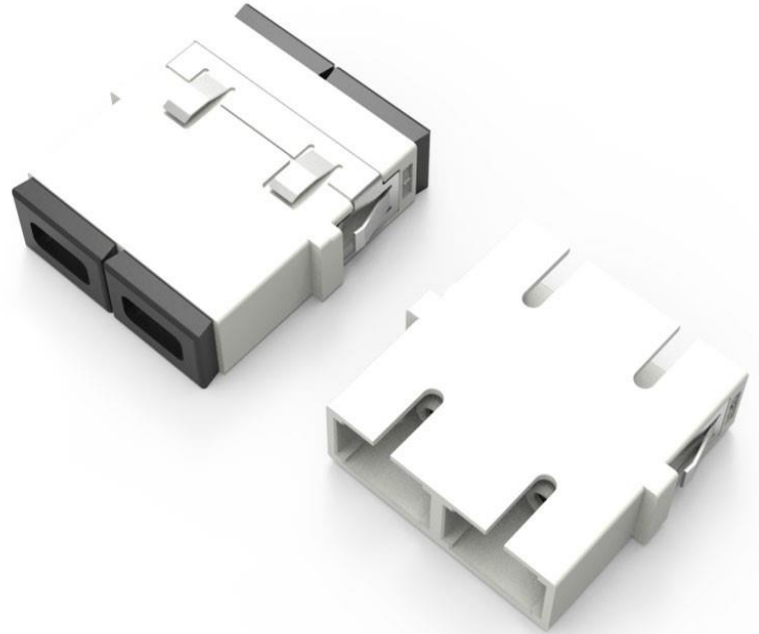

**Technical Parameter:** IL≤0.2db(SM) / IL≤0.1db (MM)

**Material:** PBT+GF (UL94-V0)

**Mechanical Durability:** ≥1000/Boot

**Applications:** Fiber Optic Cassettes / Fiber Optic Patch Panel/  
Fiber Optic Distribution Box/ Fiber Optic Technical Box and  
others to realize the connectivity



Mode	Part Number	Color Code	Photo
SM/UPC	G2S3-3W BLU	Pantone 2151 C	
SM/APC	G2S8-8W GRE	Pantone 7739 C	
OM1/OM2	G2M3-3W BEI	Pantone 481 C	
OM3	G2OM3-30W AQU	Pantone 564 C	
OM4	G2LM3-3W MAG	Pantone 7432 C	
OM5	G2XM3-3W LIME	Pantone 2300 C	

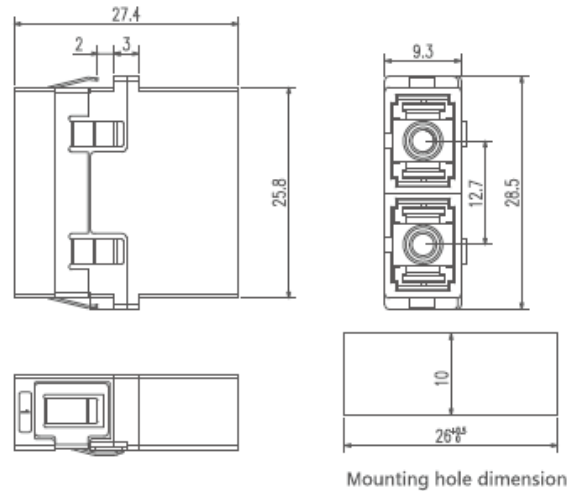

GigaRate Series Adapters 100G Support

## SC Duplex with Flange

Fiber Optic Adapters

- Tripe Sides Tight Fix Clip
- Unibody shell
- With Grade A Ceramic Sleeve 100G Support

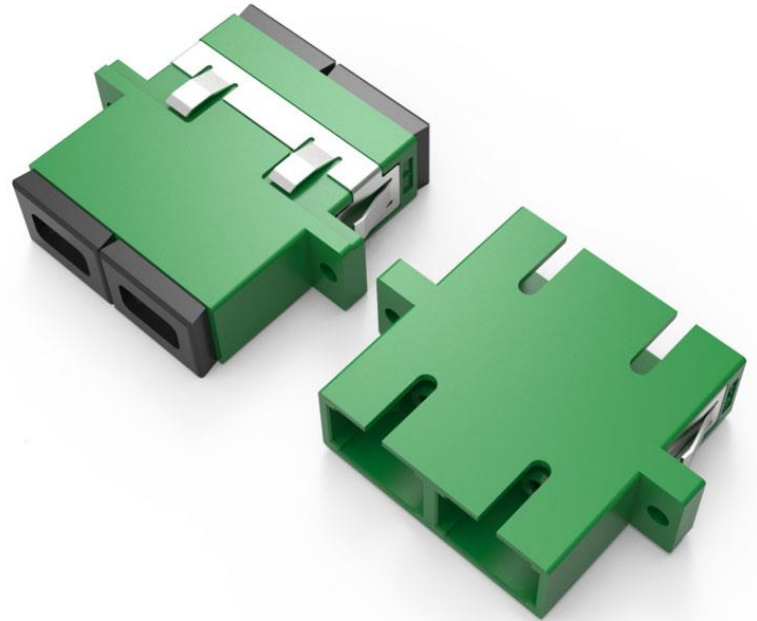

**Technical Parameter:** IL≤0.2db(SM) / IL≤0.1db (MM)

**Material:** PBT+GF (UL94-V0)

**Mechanical Durability:** ≥1000/Boot

**Applications:** Fiber Optic Cassettes / Fiber Optic Patch Panel/  
Fiber Optic Distribution Box/ Fiber Optic Technical Box and  
others to realize the connectivity

Mode	Part Number	Color Code	Photo
SM/UPC	G2S3-3F BLU	Pantone 2151 C	
SM/APC	G2S8-8F GRE	Pantone 7739 C	
OM1/OM2	G2M3-3F BEI	Pantone 481 C	
OM3	G2OM3-30F AQU	Pantone 564 C	
OM4	G2LM3-3F MAG	Pantone 7432 C	
OM5	G2XM3-3F LIME	Pantone 2300 C	

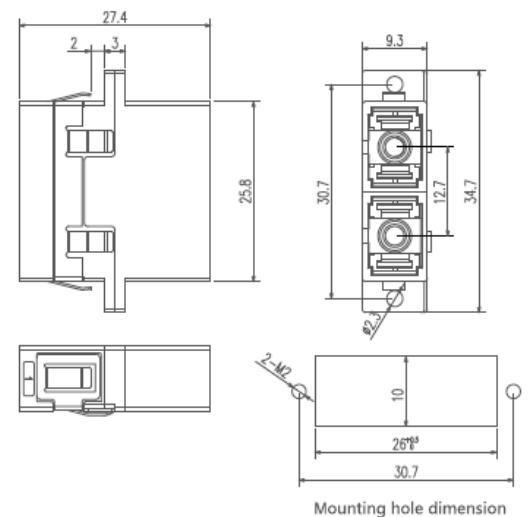

# MPO

Fiber Optic Adapters

 No.: NGBEC1903201703

 No.: ATL20181026850



GigaRate Series Adapters 100G Support

## Standard MPO with Flange

Fiber Optic Adapters

- Compatible with all MPO/MTP Connectors
- Customized Logo
- Unibody shell



**Technical Parameter:**  $IL \leq 0.35db$

**Material:** PC+GF (UL94-V0)

**Mechanical Durability:**  $\geq 1000/Boot$

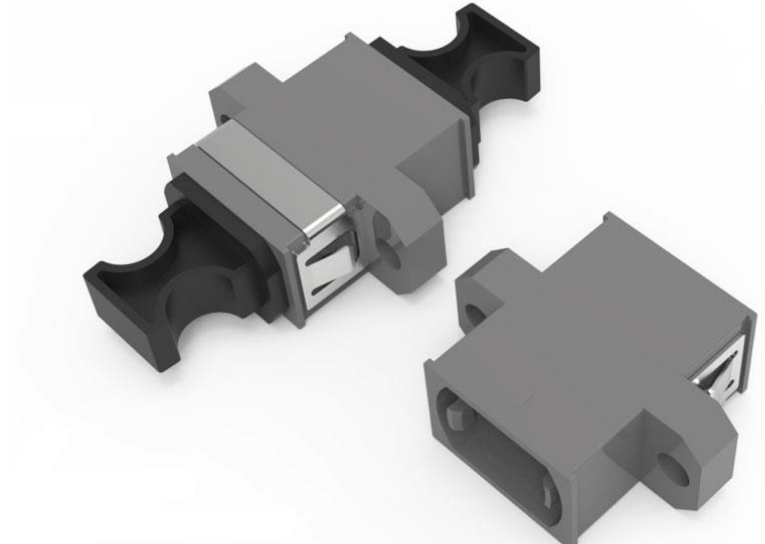
**Applications:** Fiber Optic Cassettes / Fiber Optic Patch Panel/  
Fiber Optic Distribution Box/ Fiber Optic Technical Box and  
others to realize the connectivity



Key	Part Number	Color Code	Photo
<b>Opposed</b>	G-U-MPO-SIM-E-F-AQU	Pantone 564 C	
<b>Opposed</b>	G-U-MPO-SIM-E-F-BLK	Pantone 419 C	
<b>Aligned</b>	G-U-MPO-SIM-E-F-GRA	Pantone Gray 9C	

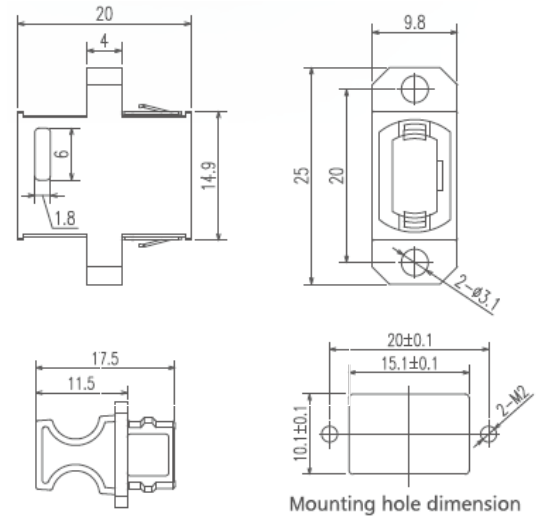

GigaRate Series Adapters 100G Support

## Standard MPO without Flange

Fiber Optic Adapters

- Compatible with all MPO/MTP Connectors
- Customized Logo
- Unibody shell



**Technical Parameter:** IL≤0.35db

**Material:** PC+GF (UL94-V0)

**Mechanical Durability:** ≥1000/Boot

**Applications:** Fiber Optic Cassettes / Fiber Optic Patch Panel/  
Fiber Optic Distribution Box/ Fiber Optic Technical Box and  
others to realize the connectivity



Key	Part Number	Color Code	Photo
<b>Opposed</b>	G-U-MPO-SIM-E-W-AQU	Pantone 564 C	
<b>Opposed</b>	G-U-MPO-SIM-E-W-BLK	Pantone 419 C	
<b>Aligned</b>	G-U-MPO-SIM-E-W-GRA	Pantone Gray 9C	

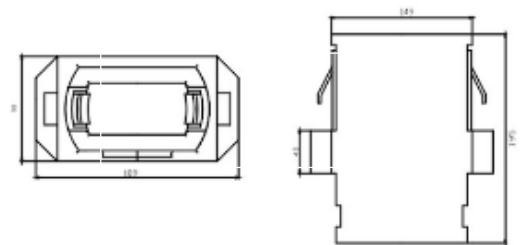



# Other

Fiber Optic Adapters

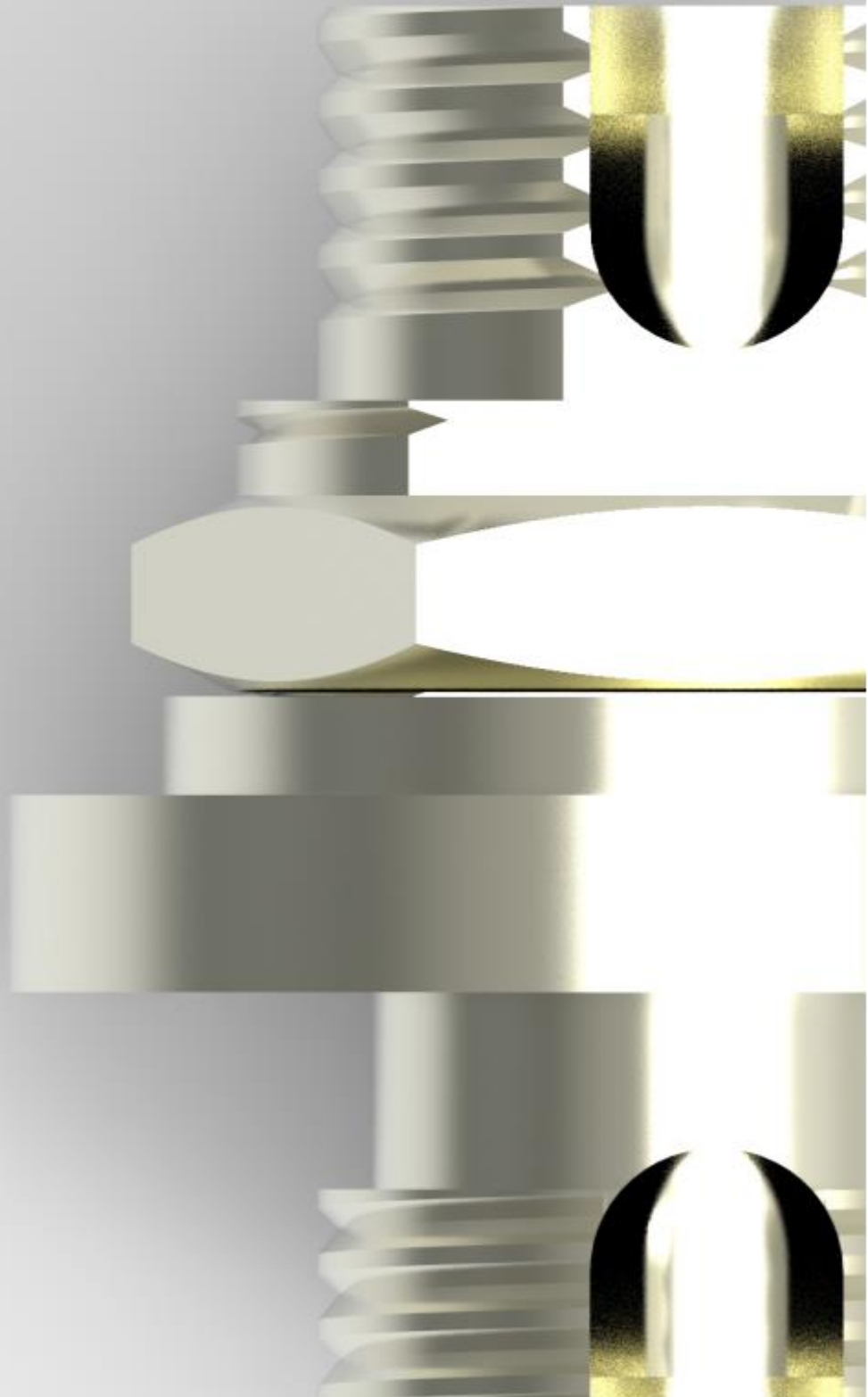

## GigaRate Series

### FC

#### Fiber Optic Adapters

- Square/Diamond/Double D/Single D
- Square Type Available With Laser Logo
- Optional Copper/Zinc Alloy Material
- With Grade A ceramic Sleeve

**Technical Parameter:** IL≤0.2db(SM) / IL≤0.1db (MM)

**Material:** Optional Copper/Zinc Alloy Material

**Mechanical Durability:** ≥1000/Boot

**Applications:** Fiber Optic Patch Panel/ Fiber Optic Distribution Box/ Fiber Optic Technical Box and others to realize the connectivity

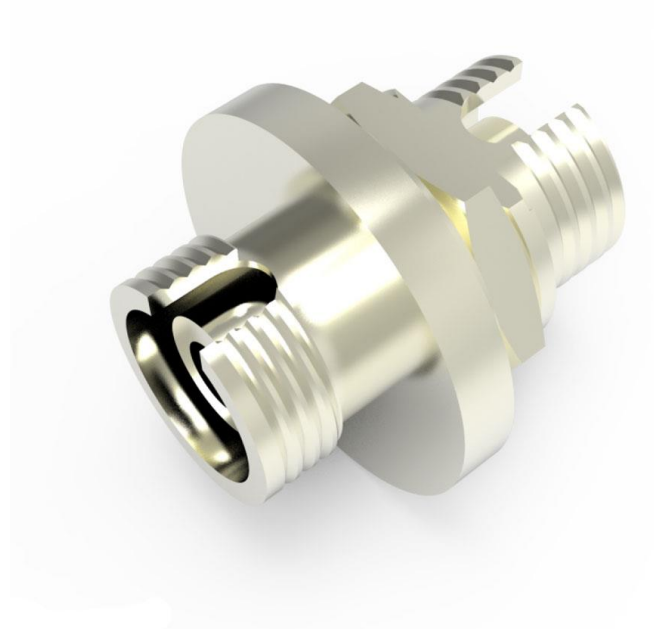

Mounting Hole	Part Number	Material	Photo
SD	G1S4-4 SD	Optional Copper/ Zinc Alloy Material	
DD	G1S4-4 DD	Optional Copper/ Zinc Alloy Material	
Square	G1S4-4 U	Optional Copper/ Zinc Alloy Material	
Rhombus	G1S4-4 L	Optional Copper/ Zinc Alloy Material	

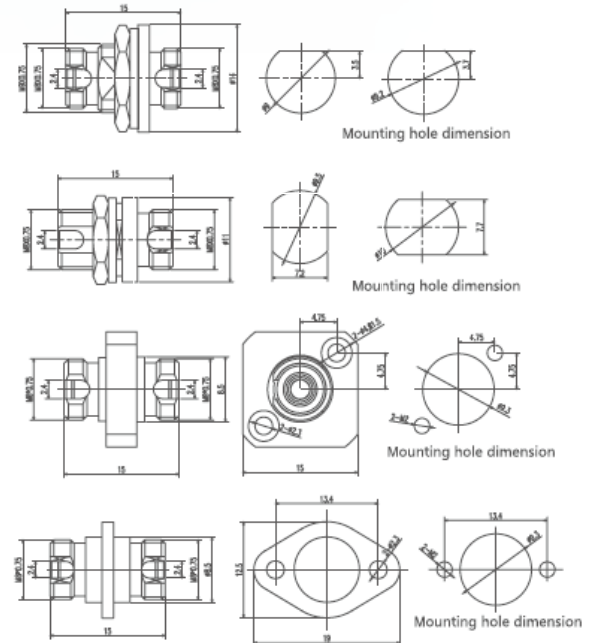

## GigaRate Series

### ST

#### Fiber Optic Adapters

- Metal Shell, High Reliability
- -40~85°C Working Environment
- Optional Copper/Zinc Alloy Material
- With Grade A ceramic Sleeve

**Technical Parameter:** IL≤0.2db(SM) / IL≤0.1db (MM)

**Material:** Optional Copper/Zinc Alloy Material

**Mechanical Durability:** ≥1000/Boot

**Applications:** Fiber Optic Patch Panel/ Fiber Optic Distribution Box/ Fiber Optic Technical Box and others to realize the connectivity

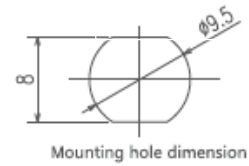
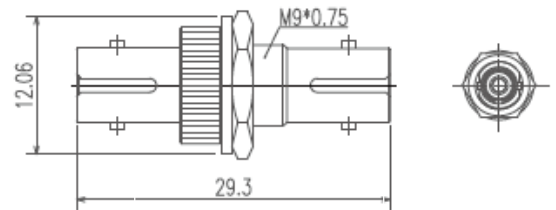
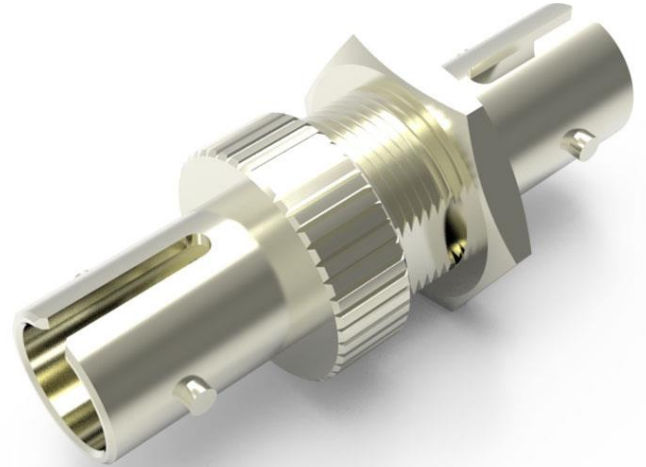

Mounting Hole	Part Number	Material	Photo
ST	G1S2-2	Optional Copper/ Zinc Alloy Material	